



**Dynamic**<sup>®</sup>  
PROFESSIONAL SERIES 2021

[www.dynamicmixers.com](http://www.dynamicmixers.com)





## DYNAMIC

### A NEW DYNAMIC® WAY TO PREPARE FOOD

**Since creating the commercial mixer in 1964, Dynamic has continued to develop and create an entire range of culinary preparation devices, used in professional kitchens throughout the world.**

Knowledge and experience have brought great notoriety to our company. As well as being the specialist producer of commercial mixers,

DYNAMIC added to its range of products a combined vegetable slicer-food processor with an unprecedented shape and design, especially thanks to its orange soft and round base offering a perfect esthetic to professional kitchens, ideal for open kitchens.

DYNAMIC is also the manual salad spinners creator and offers a large range of manual food cutters.

French manufacturer, we have total control over all aspects of production which guarantee reliable, robust and high quality products.

Today, Dynamic is present all around the world through distributors and subsidiaries in Germany and North America. This enables Dynamic to continue to work alongside its customers, to react and respond with new products which reflect the needs of the catering and food preparation market.



**NEW 2021**

## BLEND & MIX

**The BLEND&MIX is the new indispensable tool to realize texture-modified food without altering the nutritional properties and the taste of the products. For a complete meal with raw or cooked preparations, the BLEND&MIX will suit all your expectations, ideal for hospitals, residential care homes or nurseries.**

Thanks to all its innovations : a removable scrapper arm, a variable speed adjustable until 3500rpm, a micro-serrated knife with reversible rotation direction and a programmable timer, the BLEND&MIX is the most complete and innovative device of its kind on the adapted-catering market.

In terms of hygiene, its waterproof control panel with rounded corners and without apparent knob is a guarantee for HACCP norms.



DISCOVER ON PAGE 41

**DYNAMIX® / MINI SERIES**

PAGE 8



Technical description and accessories on pages 12 - 13



**JUNIOR SERIES**

PAGE 14



Technical description and accessories on pages 16 - 17

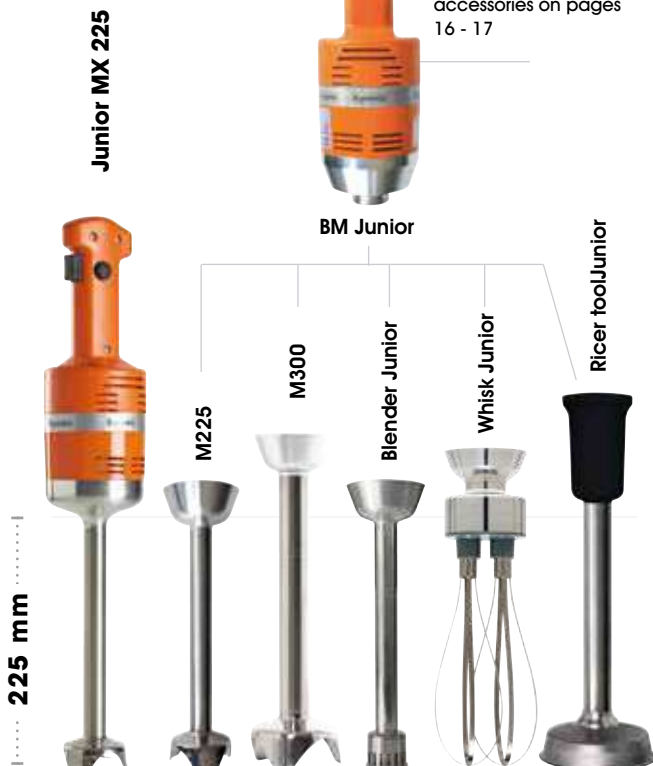

**SENIOR SERIES**

PAGE 18



Technical description and accessories on pages 20 - 21

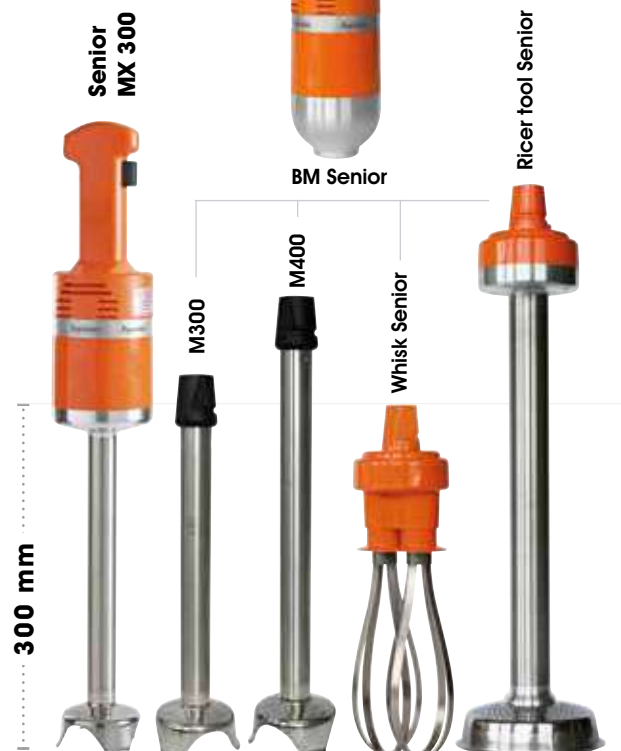

# MASTER SERIES

PAGE 22



# SMX SERIES

PAGE 28



# OUR SUPPORTS

PAGE 32



## PAN SUPPORT BRACKETS

Technical description and accessories on page 33

**SERVOMIX**  
Master and SMX Series



# VEGETABLE SLICER / FOOD PROCESSOR

PAGE 38

Technical description and accessories on pages 40



Combined

# SALAD SPINNER SERIES

PAGE 44



NEW  
MOTORIZATION

EM98 Electric



**WITH TIMEOUT**  
(RUNNING TIME 1 MINUTE)

Technical description and accessories on pages 45

# TURBO LIQUIDIZER SERIES

PAGE 34



**Gigamix XS**



**Gigamix Standard  
or Lowered  
or Removable**

**Also exists in Blender version.**  
Technical description and accessories on pages 37



**Vegetable slicer**



**Food processor**



**BLEND & MIX**

## MANUAL SERIES

PAGE 42



**Dynacube**

Technical description and accessories on pages 43

## MISCELLANEOUS

PAGE 46



**Dynajuicer**



**FMA**



## ADVANTAGES

- **Performance:** Special tools for a smooth mix.
- **Robustness:** Stainless steel foot.
- **Usability:** Two speeds or variable speed easily switchable.
- **Hygiene:** Detachable mixer tool, tube and bell 100% in stainless steel for easy cleaning.
- **Comfort:** Lightness for easy use.
- **Versatility:** Various accessories, whisk, Dynacutter bowl, ricer tool, Blender accessory.



PROFESSIONAL  
SERIES

# DYNAMIX® NOMAD

DETACHABLE EQUIPMENT  
**220W / 250W**  
**1 / 8 L**



Delivered with a charger and Lithium-ion battery. (Charging time 45 minutes)



Compact size and low battery weight for effortless work. Quick and easy replacement

### Charger

Item code AC590

### Battery

Item code AC585

## FREEDOM OF MOVEMENT IN THE KITCHEN, DYNAMIX® NOMAD CORDLESS

Designation

### Dynamix® Nomad 160\*

Knife	2 Blades
Output	2000 mAh - 12Vdc
Total length	450 mm
Tube length + bell	160 mm
Bell diameter	55 mm
Diameter	110 mm
Weight / Packaged	1,1 Kg / 1,9 Kg
Speed R.P.M	10 000
Item code	MX130

Designation

### Dynamix® Nomad 190\*

Knife	2 Blades
Output	2000 mAh - 12Vdc
Total length	480 mm
Tube length + bell	190 mm
Bell diameter	66 mm
Diameter	110 mm
Weight / Packaged	1,5 Kg / 2,2 Kg
Speed R.P.M	10 000
Item code	MX140



**OPERATING TIME 25 MINUTES**

COMPLIANT WITH STANDARDS



\* Accessories ( except blender Dynamix ) available separately.

PROFESSIONAL  
SERIES

# DYNAMIX® V2

DETACHABLE EQUIPMENT  
**220W / 250W**  
**1 / 8 L**

## TWO SPEEDS FOR ULTRA-FAST ADJUSTMENT, DYNAMIX® V2

### Available in 3 colors

Orange color in standard.



### Dynamix® 160 V2 Orange / Black

Item code MX055

### Red / Black

Item code MX056

### White / Black

Item code MX057

### Dynamix® 190 V2 Orange / Black

Item code MX095

### Red / Black

Item code MX096

### White / Black

Item code MX097



160 mm



190 mm

Designation  
**Dynamix® DMX 160 V2\***

Knife	2 Blades
Output	220 W
Total length	395 mm
Shaft length	160 mm
Bell diameter	55 mm
Diameter	70 mm
Weight / Packaged	1 Kg / 1,2 Kg
Speed 1 R.P.M	8000
Speed 2 R.P.M	13 000
Item code	according to colors

Designation  
**Dynamix® DMX 190 V2\***

Knife	2 Blades
Output	250 W
Total length	425 mm
Shaft length	190 mm
Bell diameter	66 mm
Diameter	70 mm
Weight / Packaged	1,2 Kg / 1,5 Kg
Speed 1 R.P.M	8000
Speed 2 R.P.M	13 000
Item code	according to colors

\* Others accessories available separately.

PROFESSIONAL  
SERIES

**DYNAMIX®**

DETACHABLE EQUIPMENT  
**220W / 250W**  
**1 / 8 L**

**ESPECIALLY DESIGNED  
FOR SMALL PREPARATIONS,  
SAUCES AND EMULSIONS.**  
**DYNAMIX®**

DYNAMIX / MINI



Designation

**Dynamix® DMX 160**

Knife	2 Blades
Output	220 W
Total length	395 mm
Shaft length	160 mm
Bell diameter	55 mm
Diameter	70 mm
Weight / Packaged	1 Kg / 1,2 Kg
Speed R.P.M.	3 000 / 13 000
Item code	MX050

Designation

**Dynamix® DMX 190**

Knife	4 Blades
Output	250 W
Total length	425 mm
Shaft length	190 mm
Bell diameter	66 mm
Diameter	70 mm
Weight / Packaged	1 Kg / 1,5 Kg
Speed R.P.M.	3 000 / 13 000
Item code	MX090

Designation

**Dynamix® DMX 160 Blender**

Hammer	Star-shaped
Output	220 W
Total length	395 mm
Shaft length	160 mm
Bell diameter	35 mm
Diameter	70 mm
Weight / Packaged	1,2 Kg / 1,5 Kg
Speed R.P.M.	3 000 / 13 000
Item code	MX100

# PROFESSIONAL SERIES DYNAMIX® / MINI

## ACCESSORIES



Accessories available separately.



Designation  
**BM Dynamix®**

	BM 160	BM 190
Output	220 W	250 W
Item code	AC515	AC514



	Designation <b>M160</b>	Designation <b>M190</b>	Designation <b>M Shake 190</b> Adaptable with the graduated bowl AC510
Knife	2 Blades	4 Blades	4 Blades
Speed R.P.M.	3 000 / 13 000	3 000 / 13 000	3 000 / 13 000
Mixer head diameter	55 mm	66 mm	66 mm
Item code	AC521	AC550	AC530

Removable whisks for easy cleaning



2 blade-knife



4 blade-knife



Skimmer disc



Beater disk

	Designation <b>Blender Dynamix®</b>	Designation <b>Whisk Dynamix®</b>	Designation <b>Ricier tool</b>	Designation <b>Blade pack</b>
Speed R.P.M.	3 000 / 13 000	600 / 2 500	70 / 300	
Item code	AC560	AC516	AC517	AC540

# DETACHABLE EQUIPMENT PACKS



Variable speed

DYNAMIX / MINI



Designation  
**MD95**

Knife	4 Blades / 2 Blades
Output	250 W
Total length	445 mm
Shaft length	160 mm
Bell diameter	55 mm
Diameter	72 mm
Weight / Packaged	1,2 Kg / 1,5 Kg
Speed R.P.M.	11 500
Item code	MX008 / MX010



Designation

**Dynamix® Combi 160** ① + ② + ③

1 Motor block	220 W
1 Mixer tool	160 mm
Knife	2 Blades
1 Whisk tool	185 mm
Item code	MF052

Designation

**Dynamix® Trio 160** ① + ② + ③ + ④

1 Motor block	220 W
1 Mixer tool	160 mm
Knife	2 Blades
1 Whisk tool	185 mm
1 Ricer tool	126 mm
Item code	MF050

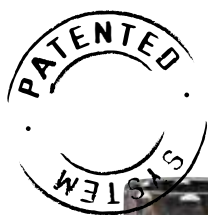

Reverse sharpened blades



Designation  
**Cutter Bowl  
Dynamix®**



Designation  
**Graduated bowl  
Dynamix®**



Designation  
**Stainless steel jug  
Dynamix®**  
Suitable induction



Designation  
**Support Dynamix®**  
Available in black

Speed R.P.M.	600 / 2 500			
Item code	AC518	AC510	AC513	SM030 / SM030N



## ADVANTAGES

- **Performance:** Special tools for a smooth mix.
- **Robustness:** Stainless steel attachment.
- **Usability:** Variable speed easily switchable.
- **Hygiene:** 100% detachable foot, tube and bell, 100% in stainless steel for easy cleaning.
- **Comfort:** Lightness for easy use.
- **Versatility:** Various accessories, whisk, Dynacutter bowl, ricer tool, Blender foot.
- **Safety:** Unlocking safety feature.

PROFESSIONAL  
SERIES  
**JUNIOR**

MONOBLOCK  
EQUIPMENT  
**270 W**  
**1 / 25 L**

**THE LIGHTEST MIXER ON THE  
MARKET IN ITS CATEGORY.**

Designation  
**Junior MX 225**

Knife	2 Blades
Output	270 W
Total length	505 mm
Shaft length	225 mm
Diameter	94 mm
Weight / Packaged	1,7 Kg / 2 Kg
Speed R.P.M.	12 000
Item code	MX020

Designation  
**Junior Whisk**

Output	270 W
Total length	500 mm
Shaft length	185 mm
Diameter	94 mm
Weight / Packaged	1,4 Kg / 1,7 Kg
Speed R.P.M.	300 / 2 000
Item code	FT005



**CONVENIENCE**

Wall support included  
Item code 089959

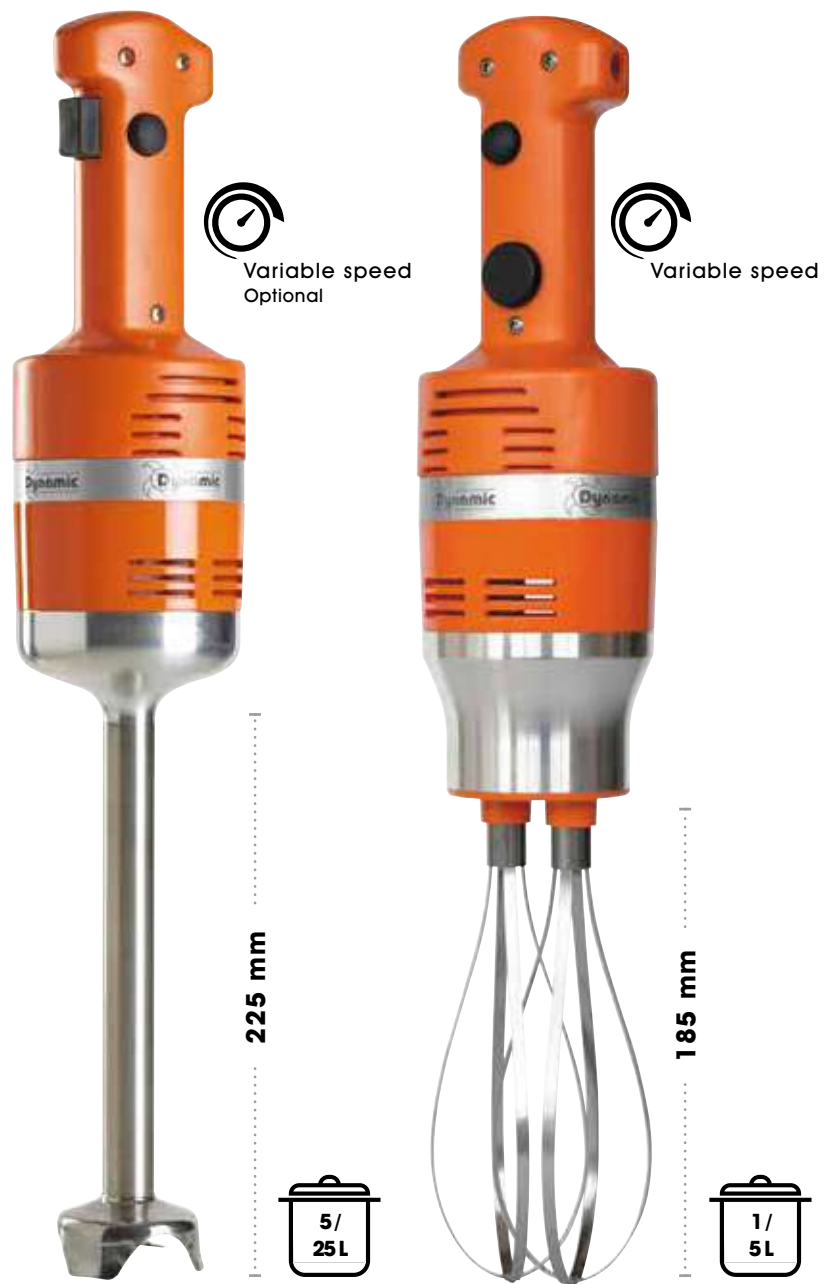
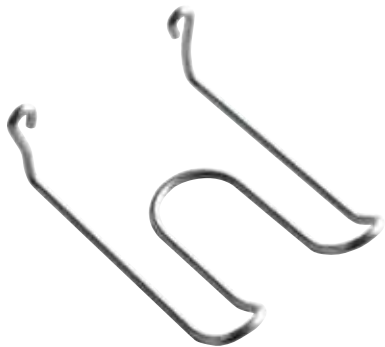

COMPLIANT WITH STANDARDS



# PROFESSIONAL SERIES JUNIOR

## ACCESSORIES

Accessories available separately.



Designation  
**BM Junior**

Output 270 W  
Item code AC100

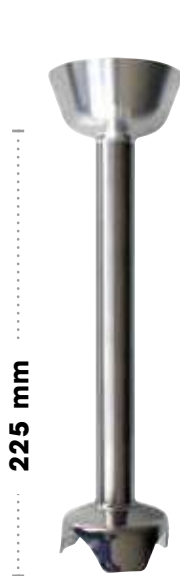

Designation  
**M225**

Speed R.P.M. 3 000 / 12 000  
Item code AC101



Designation  
**M300**

Speed R.P.M. 3 000 / 12 000  
Item code AC105

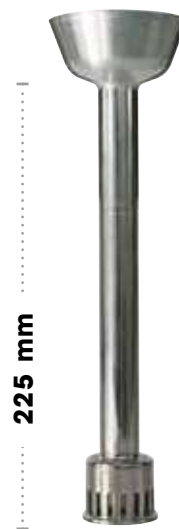

Designation  
**Blender Junior**

Speed R.P.M. 3 000 / 12 000  
Item code AC066

## DETACHABLE EQUIPMENT PACKS



Designation  
**Junior DMX 225**

1 motor block 270 W  
1 Mixer tool 225 mm  
standard Knife 2 Blades  
Item code MX021.V



Designation  
**Junior Combi 225**

1 motor block 270 W  
1 Mixer tool 225 mm  
standard Knife 2 Blades  
1 Whisk tool 185 mm  
Item code MX022





MIXERS



BLENDER  
(SOUP)



WHISKS



FOODMILL  
RICER TOOL



CUTTER

Removable whisks for easy cleaning.



**EXTRACTABLE WHISKS**

185 mm

Designation  
**Whisk Junior**

Speed R.P.M. 600 / 2 500  
Item code AC102



200 mm

Designation  
**Ricer tool Junior**

70 / 300  
Item code AC103

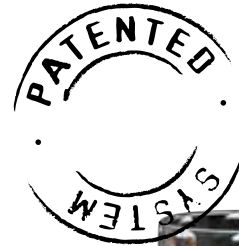

Reverse sharpened blades



Designation  
**Cutter Bowl Junior**

600 / 2 500  
Item code AC104

JUNIOR

## CONVENIENCE

Wall support included  
Item code 0880.1



Variable speed

Designation  
**Junior DMX 225 Blender**

1 motor block 270 W  
1 Blender tool 225 mm  
Item code MX110





## ADVANTAGES

- **Performance:** Special tools for a smooth mix.
- **Robustness:** Stainless steel attachments.
- **Usability:** Variable speed easily switchable.
- **Hygiene:** Detachable accessories for easy cleaning.
- **Comfort:** Lightness for easy use.
- **Versatility:** Various accessories, whisk, Dynacutter bowl, ricer tool.
- **Safety:** Unlocking safety feature.

PROFESSIONAL  
SERIES

# SENIOR

-  
MONOBLOCK  
EQUIPMENT  
**350 W**  
**20 / 40 L**



## CONVENIENCE

Wall support included  
Item code 089959

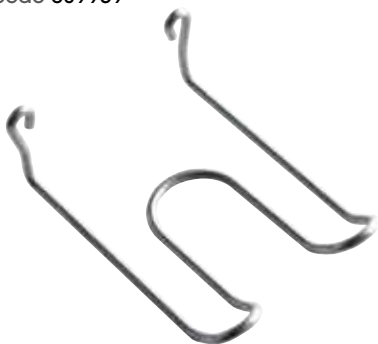

## AN EXCELLENT CHOICE FOR TRADITIONAL AND COLLECTIVE CATERING.



Variable speed  
Optional

Designation  
**Senior MX 300**

Knife	3 Blades
Output	350 W
Total length	600 mm
Shaft length	300 mm
Diameter	97 mm
Weight / Packaged	2,4 Kg / 2,9 Kg
Speed R.P.M.	9 500
Item code	MX007



COMPLIANT WITH STANDARDS



SENIOR

# PROFESSIONAL SERIES SENIOR

## ACCESSORIES

Accessories available separately.



Variable speed

Designation  
**BM Senior**

Output 350 W

Item code AC005

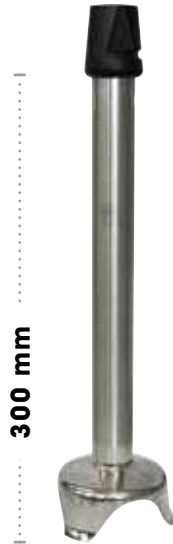

300 mm

Designation  
**M300**

Speed R.P.M. 2 800 / 9 500

Item code AC006



400 mm

Designation  
**M400**

Speed R.P.M. 2 800 / 9 500

Item code AC016

Removable whisks for easy cleaning.

**EXTRACTABLE WHISKS**



205 mm

Designation  
**Whisk Senior**

Speed R.P.M. 300 / 900

Item code AC007



MIXERS



WHISKS



FOODMILL  
RICER TOOL



CUTTER

**EXCLUSIVE PRODUCT**



Stainless steel perforated grid and blade can easily be dismantled for cleaning.



420 mm

Designation  
**Ricer tool Senior**

Speed R.P.M. 100 / 600

Item code AC004



Designation  
**Cutter Bowl inox Senior**

Speed R.P.M. 400 / 1 500

Item code AC055

# DETACHABLE EQUIPMENT PACKS



Designation  
**Senior DMX 300**

1 motor block	350 W
1 Mixer tool	300 mm
Knife	3 Blades
Item code	MX006



Designation  
**Senior Combi 300**

1 motor block	350 W
1 Mixer tool	300 mm
Knife	3 Blades
1 Whisk tool	205 mm
Item code	MF003

SENIOR

## CONVENIENCE

Wall support included  
Item code 0880



## EASY MAINTENANCE

Easily detachable without any special tool.  
Reinforced seal (attached double lip), specially coated shafts with anti-oxidation (anodising) for perfect hygiene.



## QUICK ASSEMBLY



## ADVANTAGES

- **Performance:** Special tools for a smooth mix.
- **Robustness:** Stainless steel foot.
- **Usability:** Variable speed easily switchable.
- **Hygiene:** Detachable foot and bell without tools, tube and bell 100% in stainless steel for easy cleaning.
- **Comfort:** Lightness for easy use.
- **Versatility:** Various accessories, whisk, Dynacutter bowl, ricer tool, blender foot.
- **Safety:** Unlocking safety feature.
- **Output:** New motorization for a better output.

PROFESSIONAL  
SERIES  
**MASTER**

-  
MONOBLOCK  
EQUIPMENT  
**600 W**  
**40 / 100 L**



  
Variable  
speed  
Optional

410 mm



  
Variable  
speed  
Optional

500 mm

COMPLIANT WITH STANDARDS



**CONVENIENCE**

Wall support included  
Item code 0881

Designation  
**Master MX 91-410**

Knife	3 Blades
Output	600 W
Total length	715 mm
Shaft length	410 mm
Diameter	110 mm
Weight / Packaged	3,4 Kg / 3,8 Kg
Speed R.P.M.	10 500
Item code	MX005

Designation  
**Master MX 91-500**

Knife	3 Blades
Output	600 W
Total length	800 mm
Shaft length	500 mm
Diameter	110 mm
Weight / Packaged	3,6 Kg / 4 Kg
Speed R.P.M.	10 500
Item code	MX045

PROFESSIONAL  
SERIES  
**MASTER**

-  
MONOBLOCK  
EQUIPMENT  
**600 W**  
**40 / 100 L**



**EXTRACTABLE  
WHISKS**

Removable whisks  
for easy cleaning.



Variable  
speed  
Optional

410 mm



Variable  
speed

245 mm

Designation  
**Master MX 410**

Knife	3 Blades
Output	600 W
Total length	720 mm
Shaft length	410 mm
Diameter	122 mm
Weight / Packaged	3,5 Kg / 4,1 Kg
Speed R.P.M.	10 500
Item code	MX004

Designation  
**Master Whisk**

Output	600 W
Total length	650 mm
Length. Whisk	245 mm
Diameter	110 mm
Weight / Packaged	3,3 Kg / 3,7 Kg
Speed R.P.M.	300 / 900
Item code	FT001



# DETACHABLE EQUIPMENT PACKS



 Variable speed

Designation **Master DMX 410.H** 

1 motor block	600 W
1 Mixer tool	410 mm
Knife	3 Blades
Item code	MX003.H



 Variable speed

Designation **Master DMX 410 Blender**

1 motor block	600 W
1 Mixer tool	410 mm
Hammer	Star shaped
Item code	MX120



 Variable speed

Designation **Master Combi 410.H** 

1 motor block	600 W
1 Mixer tool	410 mm
Knife	3 Blades
1 Whisk tool	245 mm
Item code	MF002.H



 Variable speed

Designation **Master Trio 410.H** 

1 motor block	600 W
1 Mixer tool	410 mm
Knife	3 Blades
1 Whisk tool	245 mm
1 Ricer tool	420 mm
Item code	MF001.H

# PROFESSIONAL SERIES MASTER

## DETACHABLE EQUIPMENT ACCESSORIES

Accessories available separately.

**ENHANCED VERSATILITY!  
USE UP TO 12 ATTACHMENTS WITH ONLY 1 MOTOR BLOCK.**



Designation  
**BM Master**  
Output 600 W  
Item code AC001



Designation	<b>M410.H</b>	<b>M410.HC</b>	<b>M500</b>	<b>Blender Master</b>
Speed R.P.M.	3 000 / 10 500	3 000 / 10 500	3 000 / 10 500	3 000 / 10 500
Item code	AC002.H	AC002.HC	AC500	AC070



Designation  
**Whisk Master**  
Speed R.P.M. 300 / 900  
Item code AC003



Designation  
**Ricer tool Master**  
Speed R.P.M. 100 / 600  
Item code AC004



Designation	<b>M300 CC Master</b>	<b>Blender CC Master</b>
Speed R.P.M.	3 000 / 10 500	3 000 / 10 500
Item code	AC260.HC	AC265



MIXERS



BLENDER  
(SOUP)



WHISKS



FOODMILL  
RICER TOOL



CUTTER

CleanUp System

### FULLY REMOVABLE MIXER FOOT AND BELL

For easy cleaning, maintenance and perfect hygiene. All stainless steel for increased durability of your attachment. Dishwasher proof. **This DYNAMIC exclusive system complies with HACCP requirements.**

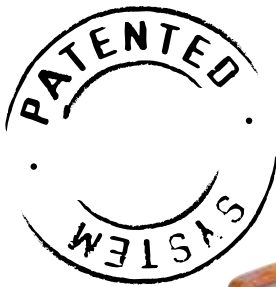

Designation

### Cutter Bowl Master

A selection of knives (standard or serrated)

Speed R.P.M. 400 / 1500

Item code AC055

### CONVENIENCE

Wall support included

Item code 0880



WHISKS

420 mm



600 mm

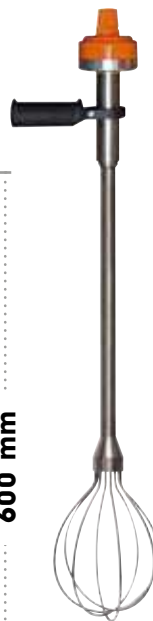

700 mm

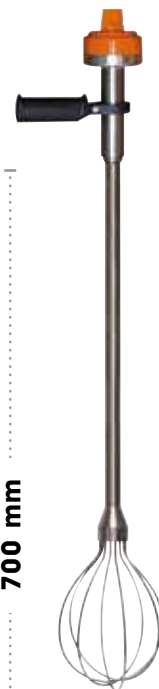

Designation

**FM420**

Speed R.P.M.

100 / 600

Item code

AC202

**FM600**

100 / 600

AC200

**FM700**

100 / 600

AC201

MASTER

PROFESSIONAL  
SERIES

**SMX**

-  
MONOBLOCK /  
DETACHABLE EQUIPMENT

**850 / 1000 W**  
**75 / 300 L**



## ADVANTAGES

- **Performance:** Special tool for a smooth mix.
- **Robustness:** Stainless steel foot.
- **Hygiene:** Completely removable foot and bell without tools.  
Tube and bell 100% stainless steel for easy cleaning.
- **Comfort:** Easy use thanks to its support.
- **Safety:** Unlocking safety feature.
- **Output:** New motorization for a better output.

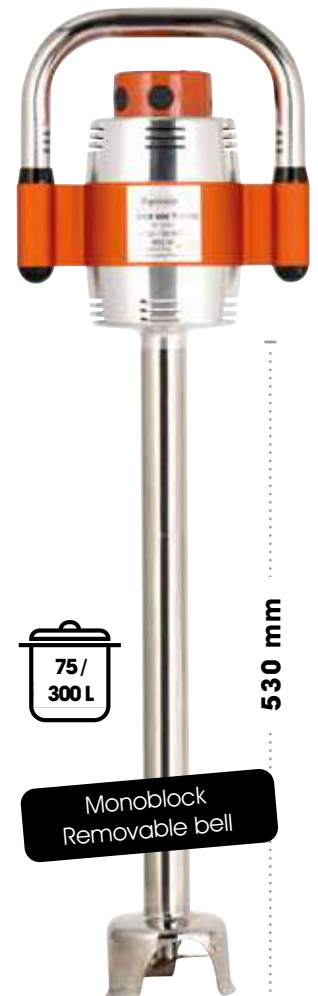

Designation  
**SMX 600 Turbo**

Knife	3 Blades
Output	850 W
Total length	800 mm
Shaft length	530 mm
Diameter	125 mm
Weight / Packaged	6,1 Kg / 7,7 Kg
Speed R.P.M.	11 000
Item code	MX002T

# SMX SERIES

Special production kitchens  
and intensive use.



Designation  
**SMX 700 Turbo**

Knife	3 Blades
Output	925 W
Total length	870 mm
Shaft length	600 mm
Diameter	125 mm
Weight / Packaged	6,5 Kg / 8,0 Kg
Speed R.P.M.	11 000
Item code	MX040T

Designation  
**SMX 800 Turbo**

Knife	3 Blades
Output	1000 W
Total length	960 mm
Shaft length	680 mm
Diameter	125 mm
Weight / Packaged	6,7 Kg / 8,2 Kg
Speed R.P.M.	11 000
Item code	MX001T

Designation  
**SMX Blender Turbo**

Hammer	Star shaped
Output	1000 W
Total length	860 mm
Shaft length	580 mm
Diameter	125 mm
Weight / Packaged	6,7 Kg / 8,2 Kg
Speed R.P.M.	11 000
Item code	MX125T

SMX PP

COMPLIANT WITH STANDARDS



# PROFESSIONAL SERIES SMX

## ACCESSORIES

Accessories available separately.



Designation

**BM SMX Turbo**

Output

1000 W

Item code

AC052T

COMPLIANT WITH STANDARDS

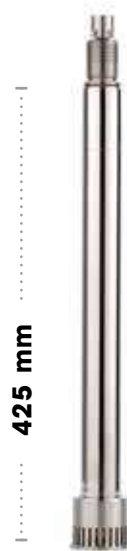
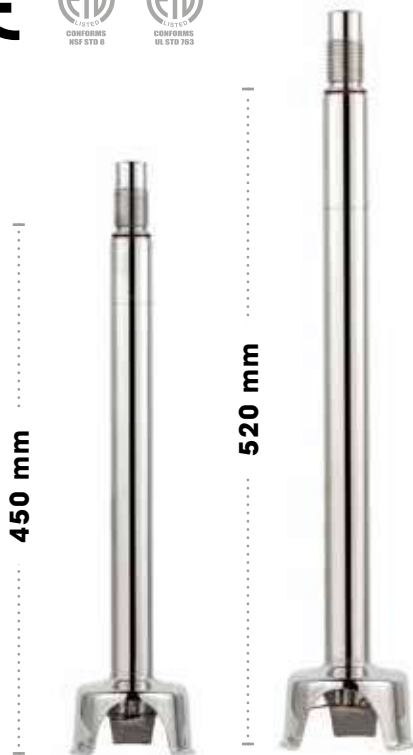

### CONVENIENCE

Wall support included

Item code 0862



Designation

**Attachment  
700 Turbo**

Designation

**Attachment  
800 Turbo**

Designation

**Blender SMX  
Turbo**

Designation

**M300 CC SMX  
Turbo**

Designation

**Blender CC SMX  
Turbo**

Speed R.P.M.

11 000

11 000

11 000

11 000

11 000

Item code

AC075T

AC076T

AC072T

AC250T

AC255T

# PROFESSIONAL SERIES RICER TOOL

MONOBLOCK /  
DETACHABLE EQUIPMENT  
**650 W**

Accessories available separately.



Designation  
**PP520**

Output	650 W
Total length	870 mm
Weight / Packaged	4,9 Kg / 5,9 Kg
Speed R.P.M.	500
Item code	PP001

**EXCLUSIVE  
PRODUCT**

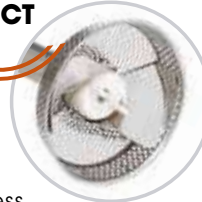

Stainless steel perforated grid and blade can easily be dismantled for cleaning.

Supplied with a supporting handle.

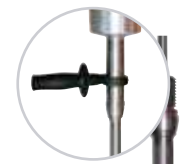

Designation  
**BM PP**

Output	650 W
Speed R.P.M.	
Item code	AC221

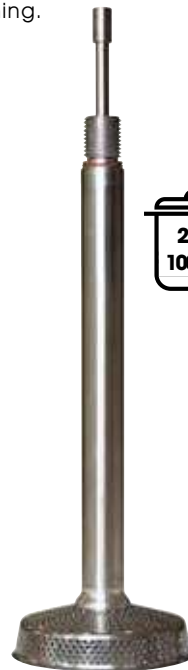

450 mm

Designation  
**Ricer tool PP**

Speed R.P.M.	150 / 500
Item code	AC220



690 mm

Designation  
**FM PP**

Speed R.P.M.	150 / 500
Item code	AC208

SMX PP

## CONVENIENCE

Wall support included  
Item code 0881





**Dynamic**

**SMX 800 TURBO**

18/ 00002

230V ~ 50/60Hz

1000 W

Poids 6,1 Kg

Fabriqué en France





ACCESSORIES

# OUR SUPPORTS

MASTER SERIES  
SMX SERIES



## SAY STOP TO MUSCULOSKELETAL DISORDERS

with this hook allowing enhanced manoeuvrability of your large mixers. This hook support is placed directly on the rim of the pot.

The SM020 Mixer hook support is standardly supplied for each detachable version MASTER & SMX SERIES.



# FOR YOUR SAFETY AND YOUR COMFORT

## WALL MOUNTING BRACKETS



SUPPORTS

## PAN SUPPORT BRACKETS

For your safety and your comfort.



Designation	<b>SM 4</b>	<b>SM 6</b>	<b>SM 8</b>	<b>SM 10</b>	<b>SM 12</b>	<b>SA</b>
Weight	1,9 Kg	2,3 Kg	2,6 Kg	2,8 Kg	3,2 Kg	0,7 Kg
Diameter of the pot	400 mm	600 mm	800 mm	1000 mm	1200 mm	Width of the pot rim 55mm*
Item code	SM001	SM002	SM003	SM004	SM005	SM006

\* Maximum diameter of the pot



## ADVANTAGES

- **Comfort** : Enhanced maneuverability thanks to the brake wheels and easy to store due to its convenient size.
- **Usability** : Compact, minimum space requirement.
- **Hygiene** : 100% stainless steel for easy cleaning.

PROFESSIONAL  
SERIES

# TURBO LIQUIDIZER

1,5 / 2,2 KW  
40 / 300 L



# GIGAMIX XS



TURBO  
LIQUIDIZER

FEEL FREE TO CONTACT US  
FOR MORE INFORMATION

Designation  
**THREE-PHASED GIGAMIX XS BLENDER**

Designation  
**SINGLE-PHASED GIGAMIX XS BLENDER**

Speed R.P.M.	2800
Voltage*	400 V, three-phased, 50 Hz
Output	1,5 Kw
Item code	TB120

Speed R.P.M.	2800
Voltage*	230 V, single-phased, 50 Hz
Output	1,5 Kw
Item code	TB120.2

COMPLIANT WITH STANDARD



# PROFESSIONAL SERIES TURBO LIQUIDIZER

## Standard, removable or lowered versions.

For heavy-duty mixing!



FEEL FREE TO CONTACT US  
FOR MORE INFORMATION



### STANDARD Version

	Designation <b>GIGAMIX 460-500</b>	Designation <b>GIGAMIX 460-500 V.V</b> Variable speed included	Designation <b>GIGAMIX Blender</b>	Designation <b>GIGAMIX Blender V.V</b> Variable speed included
Mixer attachment only	570 mm	570 mm	570 mm	570 mm
Speed R.P.M.	4000	2800 / 4000	4000	2800 / 4000
Voltage*	400 V, three-phased, 50 Hz	400 V, three-phased, 50 Hz*	400 V, three-phased, 50 Hz	400 V, three-phased, 50 Hz*
Output	2,2 Kw	2,2 Kw	2,2 Kw	2,2 Kw
Item code	TB001	TB002	TB020	TB021

### LOWERED Version

	Designation <b>GIGAMIX 460-210</b>	Designation <b>GIGAMIX 460-210 V.V</b> Variable speed included	Designation <b>GIGAMIX DMX</b>	Designation <b>GIGAMIX DMX V.V</b> Variable speed included
Mixer attachment only	570 mm	570 mm	570 mm	570 mm
Speed R.P.M.	4000	2800 / 4000	4000	2800 / 4000
Voltage*	400 V, three-phased, 50 Hz	400 V, three-phased, 50 Hz*	400 V, three-phased, 50 Hz	400 V, three-phased, 50 Hz*
Output	2,2 Kw	2,2 Kw	2,2 Kw	2,2 Kw
Item code	TB005	TB006	TB008	TB009

### REMOVABLE Version

\* Other voltages on request



**OPTIONAL Variable speed control 2800 / 4000 R.P.M.**  
Option compulsory for single-phase. Factory installed only. (Item code TB010)

## ADVANTAGES

- **Comfort:** Enhanced maneuverability thanks to the brake wheels.
- **Versatility:** Various accessories.
- **Usability:** Easy storage.
- **Hygiene:** 100% stainless steel for easy cleaning.
- **Output:** Powerful motor of 2,2 KW.
- **Performance :** time saving and maximum operating speed



# ACCESSORIES

Accessories available separately.



Designation  
**Mixer Tool Gigamix**

Speed R.P.M.	2800 / 4000
Length	133 mm
Diameter	280 mm
Item code	TB012



Designation  
**Blender Gigamix**

Speed R.P.M.	2800 / 4000
Length	93 mm
Diameter	98 mm
Item code	TB004



Designation  
**Whisk Gigamix**  
Variable speed compulsory

Speed R.P.M.	400 / 600
Length	410
Diameter	170 mm
Item code	TB014



Designation  
**Potato tool masher**  
Variable speed compulsory

Speed R.P.M.	800 / 1600
Length	250 mm
Diameter	165 mm
Item code	TB013



Designation  
**Extension arm**

Speed R.P.M.	-
Length	300 mm
Diameter	-
Item code	9333



## DYNA PUMP

With its innovative process, **DYNAMIC** transfer pump is perfectly adapted to the **GIGAMIX** blender attachment and allows the effortless and fast transfer of the mixed food preparation into packaging areas or to simply empty the pot quickly.

The DYNAPUMP allows to transfer 100 liters of water (for information, the viscosity of water is equal to 1 centipoise) in 1 minute at maximum speed (4000 rpm)



Designation  
**Dynamapump Gigamix**  
Adaptable to the blender attachment only

Item code	TB030
Diameter	178 mm



Designation  
**Gigamix Gun**  
Optional

Item code	TB040
-----------	-------



**COMPATIBLE WITH THE BLENDER ATTACHMENT ONLY**

**EMPTY YOUR POTS IN A FEW MINUTES!**

TURBO LIQUIDIZER

SERIE  
**VEGETABLE  
SLICER /  
TABLE TOP FOOD  
PROCESSOR**

-  
UNTIL 300 KG PER HOUR, SUITABLE  
FOR 400 COVERS PER SERVICE



## ADVANTAGES

- Hygiene : All accessories are dishwasher safe
- Comfort : Silent motor : 50Db without vibrations
- Usability : Designed to be used by right and left-handed
- Performance : increased productivity thanks to large discs (largest diameter on the market)

# COMBINED VEGETABLE SLICER / FOOD PROCESSOR



Designation  
**Combined Control panel Variable Speed**

Vegetable Slicer Speed R.P.M.	320 to 720 R.P.M.
Food Processor Speed R.P.M.	350 to 3500 R.P.M.
Functions	Pulse & Reverse
Output	1100 W
Item code	CL322

**PERFECT HYGIENE  
DISHWASHER PROOF  
HANDLE EASY CLIP,  
QUICK TOOL FREE ASSEMBLY  
AND DISASSEMBLY**

**REGISTERED MODEL**

**DELIVERED WITH STANDARD KNIFE**



Designation  
**Combined Variable Speed**  
digital display screen

Vegetable Slicer Speed R.P.M.	320 to 720 R.P.M.
Food Processor Speed R.P.M.	350 to 3500 R.P.M.
Functions	Pulse, reverse*, countdown timer*, timer*
Output	1100 W
Item code	CL350

\* Food processor only

# VEGETABLE SLICER WITH A LARGE RANGE OF STAINLESS STEEL DISCS



Designation  
**Vegetable slicer 1 Speed**

Designation  
**Vegetable slicer 2 Speeds**

Speed R.P.M.	320 R.P.M.	320 and 640 R.P.M.
Functions	-	-
Speed	-	-
Output	1100 W	1100 W
Item code	CL100	CL110

Designation  
**Vegetable slicer VS**  
control panel

Designation  
**Vegetable slicer VS Screen**  
digital display screen

Speed R.P.M.	320 to 720 R.P.M.	320 to 720 R.P.M.
Functions	Pulse	Pulse
Speed	5 levels	5 levels
Output	1100 W	1100 W
Item code	CL121	CL150

**— CONVERTIBLE INTO A FOOD PROCESSOR —**

COMPLIANT WITH STANDARDS



VEGETABLE SLICER  
FOOD PROCESSOR

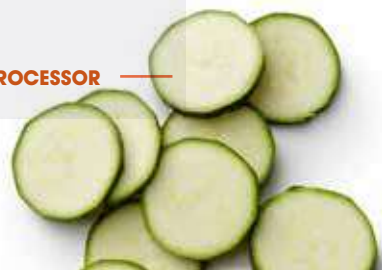

# ACCESSORIES

Accessories available separately.



## Slicing disc

Item code	Designation
CL1005	0,5 mm
CL1015	1,5 mm
CL1025	2,5 mm
CL1030	3 mm
CL1040	4 mm
CL1050	5 mm
CL1070	7 mm
CL1080	8 mm
CL1090	9 mm
CL1110	11 mm
CL1120	12 mm
CL1130	13 mm



## Grating disc

Item code	Designation
CL2002	2 mm
CL2003	3 mm
CL2005	5 mm
CL2009	9 mm



## Julienne disc

Item code	Designation
CL3032	3X2 mm
CL3042	4X2 mm
CL3044	4X4 mm
CL3055	5x5 mm
CL3052	5X2 mm
CL3088	8x8 mm

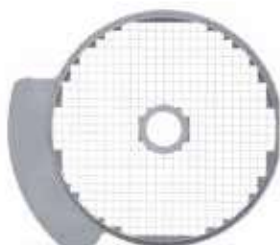

## Dicing kit

Item code	Designation
CL4008	8X8 mm
CL4010	10x10 mm



## French fries kit

Item code	Designation
CL5008	8X8 mm
CL5010	10x10 mm



## PIZZA PACK

including:  
1 slicing disc 2,5 mm,  
1 slicing disc 4mm,  
1 grating disc 7mm

Item code CL6000

## BUFFET PACK

including:  
1 slicing disc 1,5 mm,  
1 slicing disc 3mm,  
1 slicing disc 5mm,  
1 grating disc 2mm.

Item code CL6001

## BRASSERIE/CATERING PACK

including:  
1 slicing disc 1,5 mm,  
1 slicing disc 3mm,  
1 slicing disc 5mm,  
1 grating disc 2mm,  
1 julienne disc 4x4mm,  
1 julienne disc 8x8mm,  
1 dicing kit 10x10mm.

Item code CL6002

## COLLECTIVE CATERING PACK

including:  
1 slicing disc 0,5 mm,  
1 slicing disc 2,5mm,  
1 slicing disc 5mm,  
1 slicing disc 11mm,  
1 grating disc 2mm,  
1 grating disc 5mm,  
1 julienne disc 4x4mm,  
1 dicing kit 10x10mm.

Item code CL6003

## Disc support

Adjustable unit table or wall disc support

Item code CL7000





# SERIE TABLE TOP FOOD PROCESSOR, BLEND & MIX

FROM 100G TO 4KG, SUITABLE FOR 20  
TO 100 COVERS PER SERVICE

## TABLE TOP FOOD PROCESSOR

MIX, EMULSIFYING, BLENDING AND  
CHOPPING IN A FEW SECONDS



DELIVERED WITH STANDARD KNIFE

	Designation <b>Food Processor 1 Speed</b>	Designation <b>Food Processor 2 Speeds</b>	Designation <b>Food Processor VS control panel</b>	Designation <b>Food Processor VS Screen digital display screen</b>
Speed R.P.M.	1500 R.P.M.	1500 and 3000 R.P.M.	350 to 3500 R.P.M.	350 to 3500 R.P.M.
Functions	-	Pulse & Reverse	Pulse & Reverse	Pulse & Reverse, countdown timer & timer
Speed	-		10 levels	10 levels
Output	1100 W	1100 W	1100 W	1100 W
Item code	CL200	CL212	CL222	CL250

CONVERTIBLE INTO A VEGETABLE SLICER

## BLEND & MIX

FUNCTIONS 2 IN 1  
IDEAL FOR SOFT DIET PREPARATIONS.

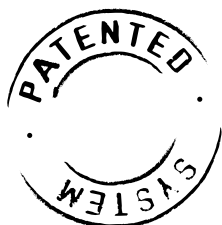

DELIVERED WITH A STANDARD BLADE  
AND A MICRO-SERRATED BLADE



	Designation <b>BLEND &amp; MIX 2V</b>	Designation <b>BLEND &amp; MIX VS control panel</b>	Designation <b>BLEND &amp; MIX VS Screen digital display screen</b>
Speed R.P.M.	1500 and 3000 R.P.M.	350 to 3500 R.P.M.	350 to 3500 R.P.M.
Functions	Pulse & Reverse	Pulse & Reverse	Pulse & Reverse, countdown timer & timer
Speed	-	10 levels	10 levels
Output	1100 W	1100 W	1100 W
Item code	CL412	CL422	CL450

### ACCESSORIES



**Standard blade**

Item code CL8001



**Serrated blade**

Item code CL8002



**Micro-serrated blade**

Item code CL8003

VEGETABLE SLICER  
FOOD PROCESSOR



## ADVANTAGES

- **Fast:** Quick installation.
- **Performance:** Quality and efficient dicing.
- **Hygiene:** Easy to clean.
- **Comfort:** Easy transport and storage.
- **Versatility:** Specific tools to allow different cuts.
- **Safety:** No direct contact with the blade.



MANUAL  
SERIES

# FOOD CUTTER

-  
**30 / 50 KG/H**

PREPARATION OF DICES,  
SLICES & STICKS.



# DYNACUBE

## N°1 MANUAL VEGETABLE CUTTERS IN THE WORLD



COMPLIANT WITH STANDARDS

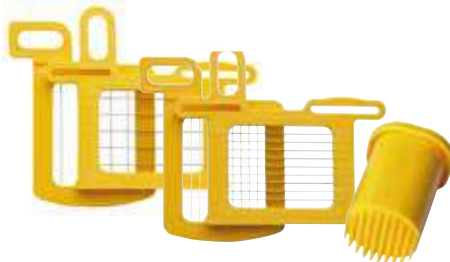

**Dynacube +  
grids 5,5x5,5  
+ with pusher**

**Dynacube +  
grids 7x7  
+ with pusher**

**Dynacube +  
grids 8,5x8,5  
+ with pusher**

**Dynacube +  
grids 10x10  
+ with pusher**

**Dynacube +  
grids 14x14  
+ with pusher**

**Dynacube +  
grids 17x17  
+ with pusher**

Diameter	400 mm					
Total height	330 mm					
Weight / Packaged	3,1 / 4,4 Kg					
Item code	CL007	CL005	CL003	CL006	CL008	CL009

**Kit grids 5,5x5,5  
+ with pusher**

**Kit grids 7x7  
+ with pusher**

**Kit grids 8,5x8,5  
+ with pusher**

**Kit grids 10x10  
+ with pusher**

**Kit grids 14x14  
+ with pusher**

**Kit grids 17x17  
+ with pusher**

Item  
Code

AC065

AC060

AC061

AC062

AC063

AC064

PROFESSIONAL SERIES

# SALAD SPINNERS

-  
MANUAL  
& ELECTRIC  
5 / 20 L



**L'Originale**



**Dynamic**

..... 342 mm .....



## E5SC Manual Sealed cover

Diameter	275 mm
Total height	342 mm
Output	-
Speed R.P.M.	-
Recommended for	1 - 2 lettuce heads
Weight / Packaged	1,6 Kg
Item code	E007



Base with suction pads  
For enhanced stability.  
(only for E20 models).



## ADVANTAGES

- **Hygiene:** Anti-bacterial incorporated, complies with HACCP requirements.
- **Comfort:** 100% watertight to avoid water leakage.
- **Performance:** Intensive use.
- **Robustness:** Gear with a stainless steel pin incorporated.



# ALWAYS ASK FOR THE ORIGINAL

REGISTERED MODELS

Anti-bacterial incorporated

NEW MOTORIZATION



E10 Manual*	E20 Manual*	E20 SC Manual* Sealed cover	EM98 Electric
330 mm	430 mm	430 mm	430 mm
420 mm	500 mm	500 mm	630 mm
-	-	-	200W
-	-	-	500
2 - 3 lettuce heads	3 - 5 lettuce heads	3 - 5 lettuce heads	3 - 5 lettuce heads
2,4 Kg / 3,0 Kg	3,6 Kg / 4,8 Kg	3,6 Kg / 4,8 Kg	8,3 Kg / 10 Kg
E001	E002	E004	E003



**WITH TIMEOUT**  
(RUNNING TIME 1 MINUTE)  
Item code E003.T

Designation	Item code
Stabilising base E20 & E20 SC	AC019
Set of gears for both E10 - E20	2815.1
Set of gears E20 SC	2815.2



COMPLIANT WITH STANDARD





## ADVANTAGES

- Ideal for juicing a large volume of lemons, oranges and grapefruit without any effort.
- Quiet
- Very sturdy
- Easy and quick dismantling and re-assembling for easy cleaning.



# MISCELLANEOUS

## DYNAJUICER

LEMONS, ORANGES AND GRAPEFRUIT JUICER.

100/150 citrus fruit per hour



Delivered with 2 juicing cones

### Dynajuicer-citrus juicer

Diameter	ø 220 mm
Total height	330 mm
Output	200 W
Speed R.P.M.	1500
Weight	3,7 Kg
Item code	PA001



1000 / 1200 mm

### Manual Whisk FMA 90

Length	1200 mm
Capacity	20 / 200 L
Weight	1,1 Kg
Item code	AC210

### Manual Whisk FMA 91

Length	1000 mm
Capacity	20 / 200 L
Weight	1,1 Kg
Item code	AC211



DISCOVER OUR RANGE OF PRODUCTS ON OUR WEBSITE

[www.dynamixmixers.com](http://www.dynamixmixers.com)



# DYNAMIC MADE IN FRANCE



## DYNAMIC

### COMMERCIAL MIXER LEADER AND SPECIALIST OUR STRENGTH, OUR DIFFERENCES !

**DYNAMIC** invented the commercial mixer in 1964 and the commercial salad spinner in 1992. DYNAMIC is dedicated to the catering industry and chefs all around the world.

**DYNAMIC** designs, manufactures and offers the largest and widest range on the market: fixed and detachable commercial mixers with a great selection of accessories providing incredible versatility.

**DYNAMIC** manufactures in its facilities in France for integrated production, and chooses the best materials available to ensure robust, reliable and high quality products.

**DYNAMIC** designs, manufactures and coils the inductors and motors used in the mixer production,

**DYNAMIC** has never stopped innovating and offers exclusive improvements to the market, such as blender attachments and clean-up system...

**DYNAMIC** offers strong and responsive after-sales service with close follow-up. All spare parts are available,

**All products are manufactured in France, for complete quality control in-house.**



Dynamic is a member of SYNEG  
(Kitchen Equipments National Unions.)

**100% FRENCH  
EXPERTISE**





# DYNAMIC ACT FOR THE ENVIRONMENT

**FROM ITS CONCEPTION, DYNAMIC TAKES GREAT CARE TO ENSURE QUALITY AND DURABILITY OF ITS PRODUCTS.**

CHOOSING THE BEST MATERIAL AVAILABLE ENSURES HIGH QUALITY PRODUCTS

## CONCEPTION



**Dynamic always takes great care in selecting the best material available for manufacturing. This ensures long and reliable years of product satisfaction.**

It helps reduce waste and limit the depletion of renewable and non-renewable resources of our planet.

## PRODUCTION



**Sustainable production methods – custom made coiled motors for enhanced reliability.**

DYNAMIC designs and manufactures the inductors and motors which are used in the construction of mixers perfectly matching power and weight ratio on all of its machines.

## REPARABILITY / RECYCLING

**All our products are designed to be easily repairable, disassembled and reassembled.**

DYNAMIC commits to repair its products for 10 years in France and around the world, and guarantees the immediate availability of the spare parts. A replenishment and a rigorous stock monitoring ensure a fast supply to every customer in the world. All spare parts are manufactured in our production sites according to the ROHS standards that stipulates the non-use of harmful substances.

**Sustainable production methods – custom made coiled motors for enhanced reliability.**

**DYNAMIC integrates in France a take-back and processing system for end-of-life of electrical and electronic equipment, the WEEE (Waste Electrical & Electronic Equipment), in accordance with the provisions of Decree N°2012/19/CE of July 4th 2012.**

This only concerns, as provided by the Decree, equipment placed on the market after August 13th 2005. The cost of end-of-life processing is an integral part of selling prices. For more information, please contact DYNAMIC France.



**All our packaging is made in recycled cardboard.**



Our products are recyclable and each factory is equipped with a recycling collect and protocol.

## CERTIFICATIONS

**All products manufactured in our factories in Vence and Mortagne sur Sèvre comply with the essential requirements of IEC, CE, ERL, UL and NSF norms. These requirements of strict quality in safety and standardization ensure to every customer powerful and consistent quality products.**



# DIGITAL PRESENCE 24/24

## OUR AFTER-SALES WEBSITE



LOG IN TO YOUR PERSONAL ACCOUNT / AFTER-SALES SERVICE

[www.sav-dynamicmixers.com](http://www.sav-dynamicmixers.com)

Create your DYNAMIC account and be able to :

- Order spare parts online
- Access the media library and personal account
- Watch tutorials

## OUR WEBSITE



DISCOVER OUR PRODUCTS AND NEWS :

[www.dynamicmixers.com](http://www.dynamicmixers.com)

- Photos and videos illustrating our products,
- Download technical sheets and flyers
- Discover recipes with DYNAMIC equipment
- Contact us easily thanks to the complete contact form.



DISCOVER ALL OUR VIDEOS ON OUR YOUTUBE CHANNEL OR ON OUR WEBSITE.



## SALES SUPPORTS MARKETING

### PACKAGING

The packaging is also part of Dynamic merchandising. Packaging is a powerful method to recognize the brand and identify the products.

### PLAY RACK

A practical and great way to visually display Dynamic products (please contact us for more information).



# AN INTERNATIONAL DISTRIBUTION NETWORK

PRESENT IN MORE THAN 120 COUNTRIES

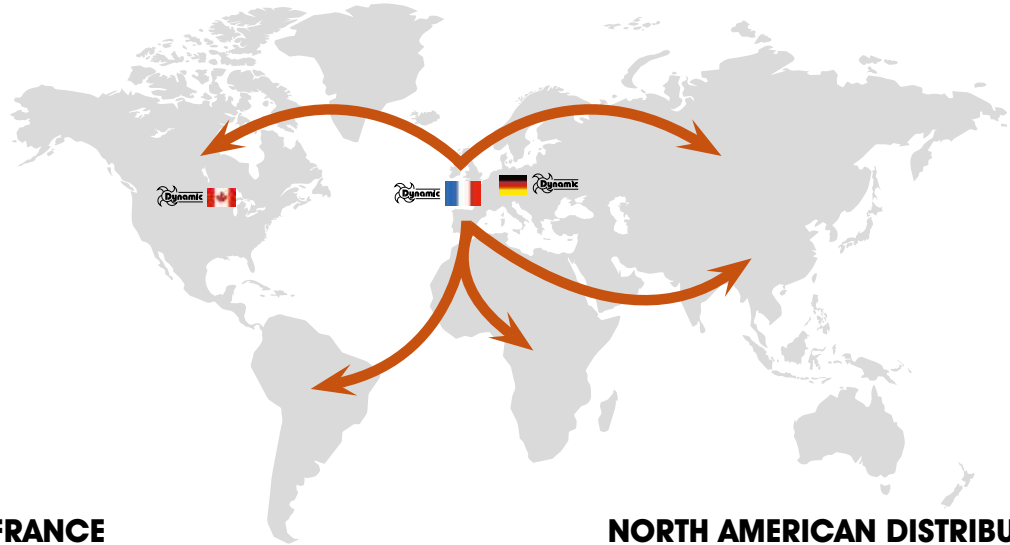

## FRANCE

518 rue Léo Baekeland  
BP57 - 85290 Mortagne / Sèvre - FRANCE  
Tel. +33 (0)2 51 63 02 72 - Fax : +33 (0)2 51 63 02 73  
e-mail : [contact@dynamicmixers.com](mailto:contact@dynamicmixers.com)  
[www.dynamicmixers.com](http://www.dynamicmixers.com)

## GERMANY

Eine starke Marke der Gruppe NADIA GMBH  
Robert-Koch-Strasse 7 - 77694 Kehl  
Tel. +49 (0)7851 886 45-0 - Fax +49 (0)7851 886 45-32  
Kontakt: [info@dynamic-professional.de](mailto:info@dynamic-professional.de)  
[www.dynamic-professional.de](http://www.dynamic-professional.de)

## NORTH AMERICAN DISTRIBUTION

### USA / Canada

Tel. : +1-800-267-7794 - +1-514-956-0127  
Fax : +1-877-668-6623 - +1-514-956-8983  
e-mail : [info@dynamicmixers.com](mailto:info@dynamicmixers.com)

### USA

1320 route 9 # 1352 - Champlain, NY - 12919  
web : [dynamicmixersusa.com](http://dynamicmixersusa.com)

### CANADA Montreal, Quebec

3227 Boul. pitfield - H4S-1H3  
web : [dynamicmixers.ca](http://dynamicmixers.ca)

## GENERAL SALES TERMS AND CONDITIONS *(Applicable to January 1<sup>st</sup> 2021)*

### 1 - GENERAL TERMS

In the absence of a special written agreement, all purchase orders imply the full and legal acceptance of these terms and conditions by the customer, notwithstanding any terms to the contrary that may feature in the customer's general purchase terms and conditions.

### 2 - ORDERS - QUOTES

Order only become final after written or tacit acceptance by DYNAMIC, hereafter referred to as "the Company". If a quote is provided, the order only becomes final after the quote is returned signed to the Company by letter, fax or any other means of transmission, within eight days of the quote being issued. Any changes to the order or the quote must be the subject of a written agreement between the Company and the customer.

### 3 - LEAD TIMES

Deliveries are made depending on supply and transport availability in the order in which the orders arrive, and according to the indications provided by the Company in its acceptance. The Company is authorised to make total or partial deliveries. Lead times are given for information and are not binding on the Company, especially in the event of force majeure or acts of God. No late delivery may entitle to the application of penalties or the payment of compensation, or deduction from the price or the cancellation of the order. In all cases, a customer shall only receive delivery if their situation relative to the Company is in order.

### 4 - DELIVERIES

Prices are given excluding VAT, FCA, packaging included. Unless there is a special indication in the order or the accepted quote, all orders are shipped with transport costs added. All the costs for express delivery are fully payable by the customer who requests this service. The goods become the property of the customer when they leave the Company shop floor, on condition of the application of the ownership clause below. Consequently all transport, customs, insurance and handling operations are at the customer's expense and at their risks and perils. The customer must make sure the delivery is compliant and check for possible damage and missing items and, where applicable, issue the necessary reserves to the relevant organisations and transporters by registered letter with acknowledgment of receipt within 72 hours. The customer shall notify the Company of this.

### 5 - RETURNS

Any product returns must be the subject of a prior formal agreement between the Company and the customer. If accepted, 10% will be deducted for costs. Special orders cannot be returned.

### 6 - WARRANTY

The Company is bound to deliver goods that are compliant with the contract and shall respond to compliance faults that are found on delivery. To be compliant with the contract, the goods must:

- Be fit for the purpose expected of a similar item and, where applicable, correspond to the description given by the Company and have the properties that the Company presented to the customer in the form of a sample or model.

- Have the characteristics that a customer may legitimately expect considering the claims made by the Company, especially in advertising.

- Or have the characteristics mutually defined between the parties.

- Or be fit for any special purpose sought by the customer, made known to the Company and accepted by the Company.

Electric appliances have a one year manufacturing defect warranty starting from the purchase date. The warranty covers all parts and labour. The warranty covers the replacement of any defective parts but does not cover damage from dropping or impacts, damage caused by improper use, incorrect connection to the power supply, or the failure to follow the usage conditions described in the instructions.

### 7 - PRICE

The prices and information featuring in the catalogues or other Company printed advertising material are only binding on the Company, which reserves the right to make any changes to the sizes, materials or weights of the products presented or described, without any duty to modify products previously delivered or of which the order is ongoing. Goods are invoiced on the basis of the price applicable at the time of the order. Payments are made to the Company headquarters. Unless special terms are agreed, orders are payable in full on shipment of the goods. A discount of 0.5% per full month, generating a proportional reduction in VAT, shall be granted on the total amount excluding VAT in the event of early payment. Any other terms of payment must be the subject of a prior agreement. On failure to pay on the contractual due date,

late payment penalties equal to 3 times the legal interest rate shall be due automatically and without notice, starting from the 1<sup>st</sup> day late. Furthermore, a fixed compensation for debt recovery costs of 40 euros shall be due automatically and without notice. If the debt recovery costs are higher than this amount, additional compensation shall be due on presentation of proof. The Company may also suspend any further deliveries.

### 8 - OWNERSHIP

The Company retains full ownership of the sold goods until full payment by the customer. However, the risks of loss, theft or deterioration of the goods are exclusively borne by the customer as soon as the goods are made available to them. The failure to pay a term may lead to a claim for existing goods.

### 9 - COPYRIGHT

The drawings, models, plans and quotes, and more generally all types of document issued by the Company carry the exclusive copyright of the Company: they may not be communicated or performed without its written authorisation. They must be returned on request by the Company.

### 10 - RENOUNCEMENT

No late delivery, omission or any tolerance by the Company in the exercise of one of its rights resulting from this agreement shall be construed as a renouncement by the Company to the exercise of that right.

### 11 - JURISDICTION

In the event of a dispute, the Company and the customer in question shall undertake arbitration out of court by a single arbitrator, chosen mutually or, failing this, appointed on request from the most diligent party by the President of the Roche-sur-Yon commercial court.

The parties renounce all right of appeal against the decision of the arbitrator which shall be final, and undertake to obey the decision without proceedings or exequatur.

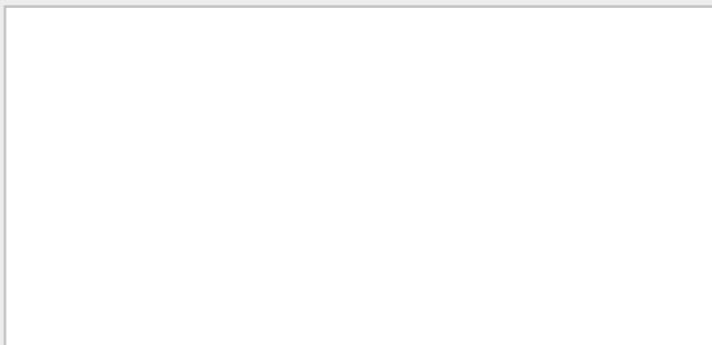
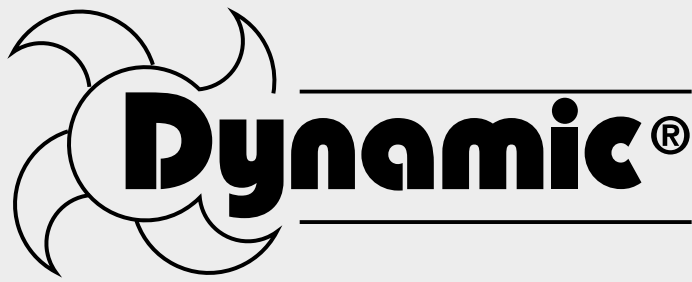

Please contact the nearest office  
for any additional information

### **DYNAMIC FRANCE**

518 rue Léo Baekeland  
BP57 - 85290 Mortagne / Sèvre - FRANCE  
Tel. +33 (0)2 51 63 02 72 - Fax : +33 (0)2 51 63 02 73  
e-mail : [contact@dynamicmixers.com](mailto:contact@dynamicmixers.com)

A NEW **DYNAMIC**® WAY TO PREPARE FOOD !  
**[www.dynamicmixers.com](http://www.dynamicmixers.com)**



Document non contractuel - Dans un souci d'évolution, nos produits et accessoires peuvent être modifiés.  
Conception Studio HV - RCS ANGERS B382 910 651. Edition Octobre 2020. Crédits Photos : STUDIO HV - J.J. BERNIER - STUDIO GINKO. Styliste culinaire - Alexandra Pasi.

